



Smart BMS with Active-Balancer

JK-BD6AxxS-6P/ JK-BD6AxxS-8P

JK-BD6AxxS-10P / JK-BD6AxxS-15P

JK-BD6AxxS-20P/ JK-B1AxxS-15P

JK-B2AxxS-15P/ JK-B2AxxS-20P

Specification and operation manual

Chengdu Jikong Technology Co., Ltd

Product warranty clause

Name : Smart BMS with Active-Balancer

Warranty period : One Year

First of all, thank you for purchasing the Smart BMS with with Active Balancer from Chengdu Jikong technology co., LTD..

Chengdu Jikong technology co., LTD. Provides quality warranty for the hardware products and accessories sold by our company. The warranty period is as shown above. During the warranty period, the company shall have the right to choose to repair or replace the whole set of products after receiving the notice of the product failure and verification. The whole set of replacement products may be new or close to new.

1. Chengdu jikong technology co., ltd. guarantees that the products are fully tested.
2. Chengdu jikong technology co., LTD does not guarantee that the products can be used without interruption during the product repair process. However, the company shall ensure that faulty products are repaired within a reasonable time.
3. The warranty period starts from the date of product delivery or the date of installation by chengdu jikong technology co., LTD. If the company's products are not installed within 30 days after the date of shipment due to the user's schedule or delay, the warranty period of the products shall be calculated from the 31st day after the date of shipment.
4. Chengdu jikong technology co., ltd. shall not provide free warranty for any product failure or damage caused by :(a) improper use or improper maintenance;(b) software, accessories, components or other items not provided by chengdu jikong technology co., LTD.:(c) unauthorized removal, modification and misuse;(d) use in excess of the scope specified in the technical specifications of the product;(e) improper transport, handling and storage;(f) failure or damage caused by other non-mass causes (e.g. earthquake, war, traffic accident,etc.).

To the extent permitted by law, the above warranty is the only express warranty and there are no other warranties, whether written or oral.Expressly disclaims any implied warranty or commercial terms.

Copyright statement

All products sold by chengdu jikong technology co., LTD. Or software and documents sold together with the hardware products are copyrighted by chengdu jikong technology co., LTD. Chengdu jikong technology co., LTD. All Copyrights in the products and documents are reserved by chengdu jikong technology co., LTD. The purchase of the product by the user does not represent any license of the user with respect to copyright. Any reproduction or sale without the written permission of Chengdu- jikong technology co., LTD is prohibited.

1. Overview	4
2. Main technical parameters	4
2.1. Main technical indexes	4
2.2. Environment conditions	6
3. Connector and interface description	7
3.1. Connector, LED lamp location identification	7
3.2. Definition of connector and LED	11
3.3. Product appearance	13
3.4. Size	14
3.5. Weight	15
4. Installation methods and precautions	15
4.1. Out-of-box check and precautions	15
4.2. Line connection	16
4.3. APP installation	25
5. Use and operation	26
5.1. Prepare and check before use	26
5.2. Power on protection board	26
5.3. APP Operating Instructions	26
5.3.1. Equipment operation	26
5.3.1.1. Device connection	26
5.3.1.2. Modify password and name	27
5.3.1 Status view	29
5.3.2 Parameter setting	32
6. Safety protection measures and precautions	37
7. Transportation and storage	37
7.1. Transportation	37
7.2. Store	38

1. Overview

Lithium battery smart BMS is a management system tailored for large capacity series lithium battery packs. It has the functions of voltage collection, active balancing of large current, overcharge over-current over-temperature protection, Coulombmeter, Bluetooth communication, GPS remote and so on. It is suitable for lithium iron phosphate, lithium ternary and other battery types.

The BMS relies on our Proprietary technology for Active Balancing. Our high current active balancing technology can ensure maximum battery consistency, improve battery life, delay Battery aging.

The BMS has a companion mobile APP that supports Android V. 7 and above and IOS operating systems. The APP can connect to the BMS via Bluetooth on your mobile phone to check the battery working status and to modify the working parameters of the BMS, control the charging, discharging switches, and so on. The BMS is small in size, simple to operate and full of functions, that can be widely used in battery PACK of small sightseeing cars, walkers, shared cars, high-power storage, base station backup power, solar power stations and other products.◦

2. Main technical parameters

2.1. Main technical indexes

The main technical indexes of 6p/8p/10p/15p series BMS' are shown in Table 1 and table 2.

Table 1 Main technical indexes of 6p/8p series BMS

Technical indicators	Product model					
	BD6A17S6P	BD6A20S6P	BD6A24S6P	BD6A17S8P	BD6A20S8P	BD6A24S8P
Li-ion Strings	7~17	7~20	7~24	7~17	7~20	7~24
Lifepo4 Strings	8~17	8~20	8~24	8~17	8~20	8~24
LTO Strings	14~17	14~20	14~24	14~17	14~20	14~24
Balance mode	Active Balance					
Balance Current	0.6A					
Internal resistance	1.53 mΩ			1.2 mΩ		
Continuous discharge Current	60A	60A	60A	80A	80A	80A
Continuous Charge Current	60A	60A	60A	80A	80A	80A
Maximum discharge current	100A	100A	100A	150A	150A	150A

Maintenance instruction of Smart BMS with Active-Balancer

Over-current protection(ADJ)	10~60 A	10~60 A	10~60 A	10~80 A	10~80 A	10~80 A
RS485 communication interface	Yes, optional (CAN/RS485 can only be selected)					
CAN communication interface	Yes, optional (CAN/RS485 can only be selected)					
Display screen interface	YES					
Entry cable	Common Port					
Unit voltage range	1~5V					
Voltage acquisition accuracy	±3mV					
Overcharge protection voltage	1.2 ~ 4.35 V adjustable					
Overcharge release voltage	1.2 ~ 4.35 V adjustable					
Overcurrent release time	2 ~ 120s adjustable					
Overdischarge protection voltage	1.2 ~ 4.35 V adjustable					
Overdischarge recovery voltage	1.2 ~ 4.35 V adjustable					
Temperature detection quantity	Three					
Temperature protection	YES					
Short circuit protection	YES					
Coulombmeter	YES					
Bluetooth function	Support Android and IOS					
GPS (optional)	Support (RS485 And GPS One out of two)					

Table 2 Main technical indexes of 10P/15P series BMS

Technical indicators	Product model					
	BD6A20S10P	BD6A24S10P	B1A20S15P	B1A24S15P	B2A24S15P	B2A24S20P
Li-ion Strings	7~20	7~24	7~20	7~24	7~24	7~24
Lifepo4 Strings	8~20	8~24	8~20	8~24	8~24	8~24
LTO Strings	14	14~20	14~20	14~24	14~24	14~24
Balance mode	主动均衡					
Balance Current	0.6A		1A		2A	
Internal resistance	1 mΩ		0.65 mΩ		0.47 mΩ	
Continuous discharge Current	100A		150A			200A
Continuous Charge Current	100A		150A			200A
Maximum discharge current	200A		300A			350A
Over-current protection(ADJ)	10~100A		10~150A			10~200A
RS485 communication interface	Yes, optional (CAN/RS485 can only be selected)					

CAN communication interface	Yes, optional (CAN/RS485 can only be selected)
Display screen interface	YES
Entry cable	Common Port
Unit voltage range	1~5V
Voltage acquisition accuracy	±3mV
Overcharge protection voltage	1.2 ~ 4.35 V adjustable
Overcharge release voltage	1.2 ~ 4.35 V adjustable
Overcurrent release time	2 ~ 120s adjustable
Overdischarge protection voltage	1.2 ~ 4.35 V adjustable
Overdischarge recovery voltage	1.2 ~ 4.35 V adjustable
Temperature detection quantity	Three
Temperature protection	YES
Short circuit protection	YES
Coulombmeter	YES
Bluetooth function	Support Android and IOS
GPS (optional)	Support (RS485 And GPS One out of two)

2.2. Environment conditions

- Operating temperature range:-30°C ~ 70°C;
- Power supply requirements: 20~100V.
- Power consumption: 8mA@100V in equilibrium state and 7mA@100V in non-equilibrium state.

3. Connector and interface description

3.1. Connector, LED lamp location identification

The two BMS connectors and the position of the LED lamp are shown in Fig. 1 and Fig. 2.

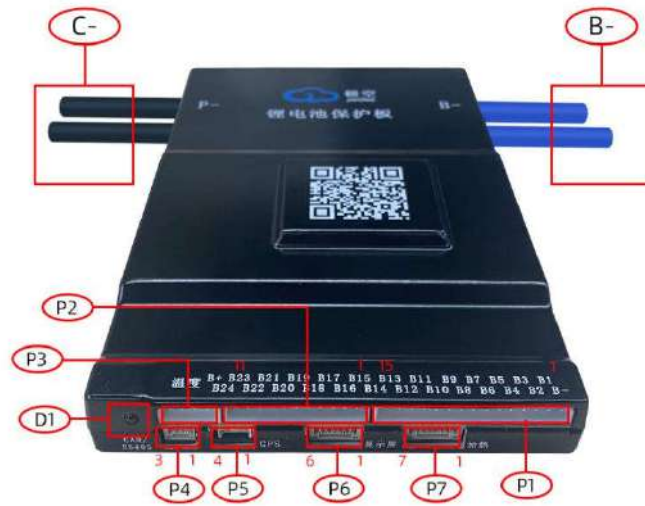

Fig. 1 BD6AxxS-10P/B1 AxxS-15P/B2AxxS-15P/B2AxxS20P connector schematic diagram

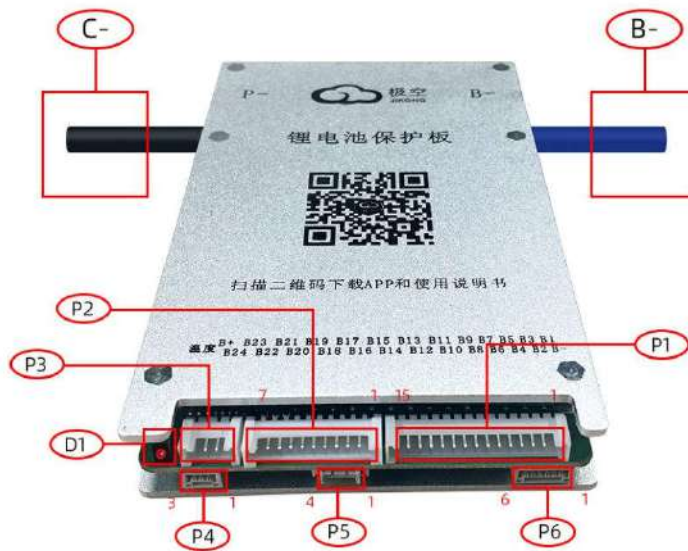
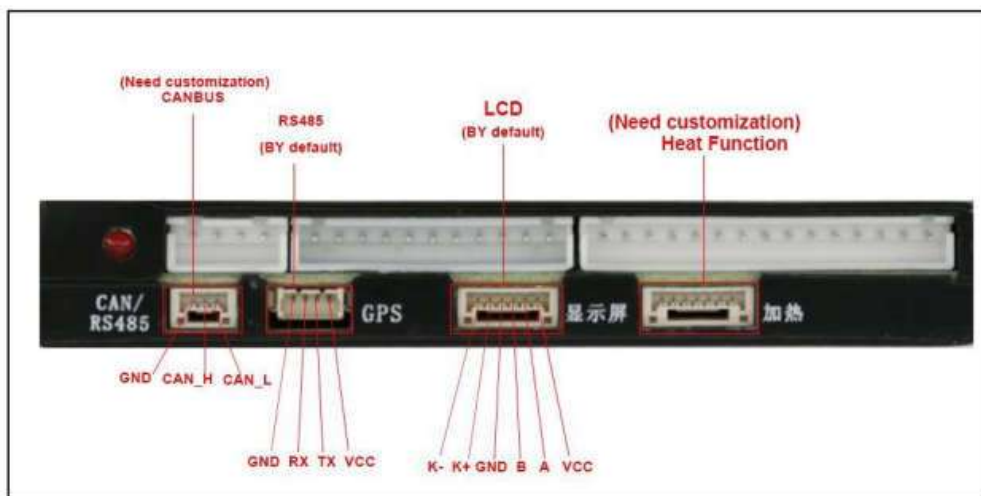
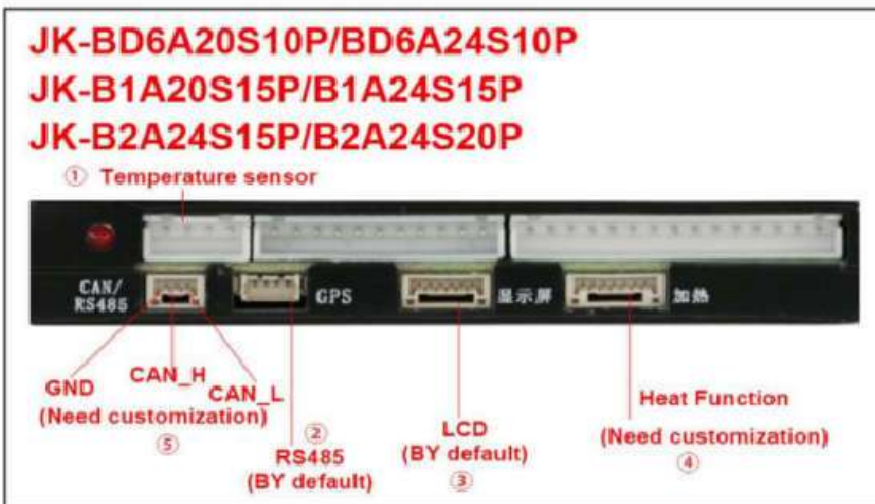
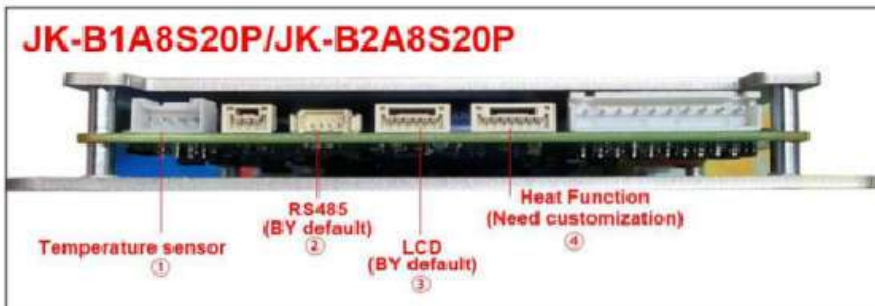
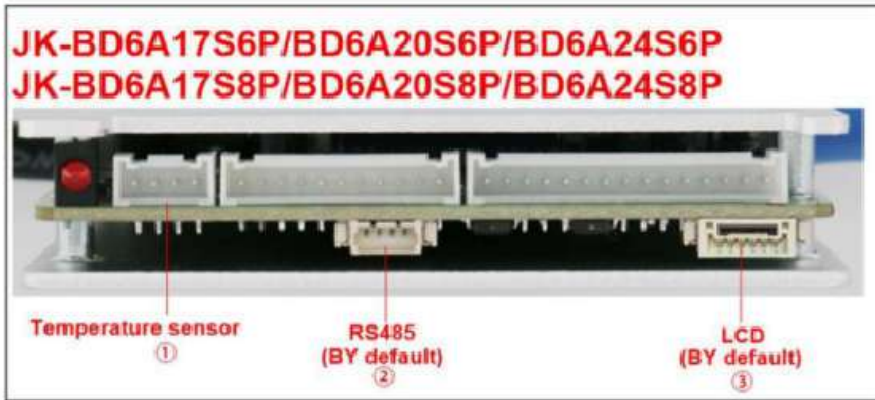

Fig. 2 BD6AxxS-6P connector schematic diagram



①:Temperature sensor

②:RS485 interface(At present, all JK BMS are configured with RS485 function by default)

③:LCD interface(At present, all JK BMS are configured with LCD interface by default)

④:Heat Function interface

(Only a BMS equipped with heating function can use heating interface)

Description of heating function:

Battery temperature is below low temperature charge protection, turn off charging, turn on heating.

Battery temperature is higher than low temperature charge recovery temperature, turn on charging, turn off heating.

Cryogenic charge protection is a parameter that can be set within APP

The heating power depends on the battery voltage and the resistance value of the heating film.

Battery voltage U.

Heating resistance R.

Power equals

U^2/R

Heating current

$I=U/R$;

The maximum I (current) of the board design is 3A

MAX heating Power 200W (100W of B2A8S20P) This condition must be met.

⑤:CANBUS interface (Needs customization)

3.2. Definition of connector and LED

See Table 3 and table 4 for definitions of bd6axxS-6p / bd6axxS-8p / bd6axxS-10pb1axxS-15p / b2axxS-15p / b2axxS20p protection board connector and LED lights.

BD6AxxS-6P/BD6AxxS-8P/BD6AxxS-10P/BD6AxxS-15P/B1AxxS-15P/B2AxxS-15P/B2AxxS20P
BMS Connector definition, LED light definition see Table 3 Table 4

Table 3 P1~P4 Interface Definition

Connector	Interface name	Pin number	BD6AxxS-6P/BD6AxxS-8P/BD6AxxS-10P B1AxxS-15P/B2AxxS-15P/B2AxxS20P	
			Name	Definition
P1	Balance and collection interface	1	B-	Battery total negative
		2	B1	Series 1 Battery Positive
		3	B2	Series 1 Battery Positive
		4	B3	Series 1 Battery Positive
		5	B4	Series 1 Battery Positive
		6	B5	Series 1 Battery Positive
		7	B6	Series 1 Battery Positive
		8	B7	Series 1 Battery Positive
		9	B8	Series 1 Battery Positive
		10	B9	Series 1 Battery Positive
		11	B10	Series 1 Battery Positive
		12	B11	Series 1 Battery Positive
		13	B12	Series 1 Battery Positive
		14	B13	Series 1 Battery Positive
		15	B14	Series 1 Battery Positive
P2		1	B15	Series 1 Battery Positive
		2	B16	Series 1 Battery Positive
		3	B17	Series 1 Battery Positive
		4	B18	Series 1 Battery Positive
		5	B19	Series 1 Battery Positive
		6	B20	Series 1 Battery Positive
		7	B21	Series 1 Battery Positive
		8	B22	Series 1 Battery Positive
		9	B23	Series 1 Battery Positive
		10	B24	24th Series Battery Positive (Battery Total Positive)
		11	B+	BMS power supply, connect battery
P3	Temperature interface	1	T1A	1st temperature sensor A pin
		2	T1B	1st temperature sensor B pin
		3	T2A	2nd temperature sensor A pin
		4	T2B	2nd temperature sensor B pin
P4	Communication interface	1	D_N	CAN_ L/RS485-N signal negative (optional function, CAN or RS485 optional)
		2	D_P	CAN_ H/RS485-P signal positive pole (optional function, CAN or RS485 optional)
		3	GND	ground

Table 4 P5~P7 Interface Definition

Connector	Interface name	Pin number	BD6AxxS-6P/BD6AxxS-8P/BD6AxxS-10P B1AxxS-15P/B2AxxS-15P/B2AxxS20P	
			Name	Definition
P5	GPS interface	1	VGPS	Output, voltage is close to B+
		2	TX	UART_TX,3.3V
		3	RX	UART_RX,3.3V
		4	GND	Power supply/signal ground
P6	Display interface	1	VCC	Display power output
		2	A	Display RS485 signal positive
		3	B	Display RS485 signal negative
		4	GND	Negative of power supply
		5	K+	Activate signal positive
		6	K-	Activate signal negative
P7	Heating interface (optional function)	1	HT-	Heating negative electrode-(BD 6AxxS-6P/BD6AxxS-8P does not have this function)
		2	HT-	Heating negative electrode-(BD 6AxxS-6P/BD6AxxS-8P does not have this function)
		3	HT-	Heating negative electrode-(BD 6AxxS-6P/BD6AxxS-8P does not have this function)
		4	HT-	Heating negative electrode-(BD 6AxxS-6P/BD6AxxS-8P does not have this function)
		5	HT-	Heating negative electrode-(BD 6AxxS-6P/BD6AxxS-8P does not have this function)
		6	CD+	Charging input positive-(BD 6AxxS-6P/BD 6AxxS-8P does not have this function)
		7	CD-	Charging input negative -(BD 6AxxS-6P/BD 6AxxS-8P does not have this function)
D1	The Bluetooth connection indicator is always on when the Bluetooth is connected to the protection board, and flashes when the connection is disconnected.			
C-	Connect external load or negative pole of charger.			
B-	Connect the negative electrode of the battery			

3.3. Product appearance

JK-BD6AxxS-10P、JK-B1AxxS-15P、JK-B2AxxS-15P、JK-B2AxxS-20P appearance is shown in Figure 3.



Figure 3. JK-BD6AxxS-10P、JK-B1AxxS-15P、JK-B2AxxS-15P、JK-B2AxxS-20P
JK-BD6AxxS-6P、JK-BD6AxxS-8P appearance is shown in Figure 4.



Figure 4 JK-BD6AxxS-6P、JK-BD6AxxS-8P

3.4. Size

JK-BD6AxxS-10P/JK-BxAxxS-15P/JK-BxAxxS-20P series protection plate size is 162mm × 102mm × 20.4mm, and the overall dimensions are shown in Figure 5.

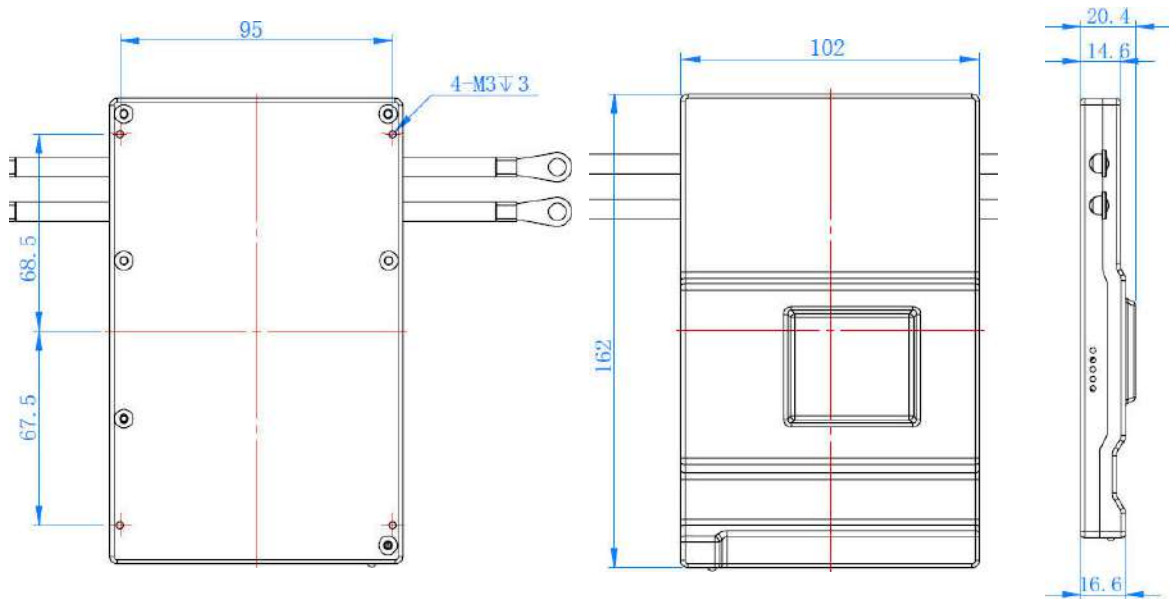

Figure 5 Overall dimensions of JK-BD6AxxS-10P/JK-BxAxxS-15P/JK-BxAxxS-20P

The protective board of JK-BD 6xxS-6P and JK-BD 6xxS-8P series are 136mm×83mm× 17.6mm in size, the overall dimensions are shown in Figure 6.

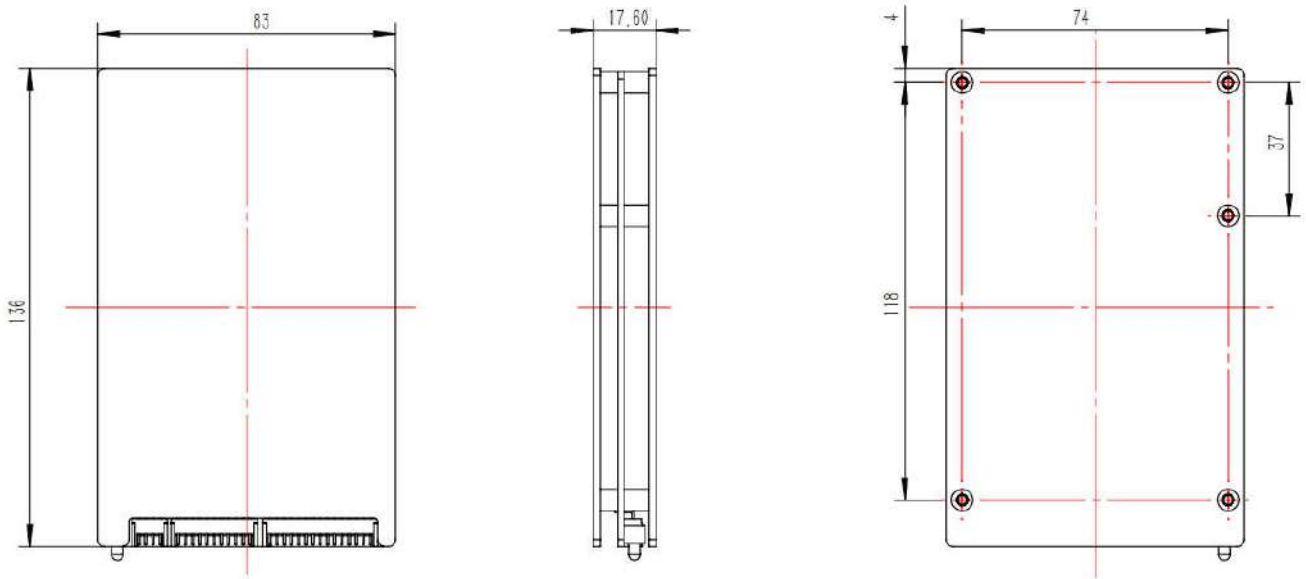

Fig. 6 Overall dimensions of JJK-BD6AxxS-6P and JK-BD6AxxS-8P series protective board

3.5. Weight

- The weight of JK-BD6AxxS-6P and JK-BD6AxxS-8P series protective board is about 257g.
- The weight of JK-BD6AxxS-10P series protective board is about 360g.
- The weight of JK-B1 AxxS-15P/JK-B2AxxS-15P/JK-B2AxxS-20P series protective board is about 430g.

4. Installation methods and precautions

4.1. Out-of-box check and precautions

The following are the out-of-box checks and precautions:

- a) The boxes, BMSs, etc. need to be handled gently and lightly, and should not be upside down as much as possible.
- b) Before opening the box, pay attention to the integrity of the package, such as whether there are any impact marks, whether there are any breakage, etc. Line connection

JK-BD 6AXS-10P, JK-BD 6AXS-15P, JK-BD 6AXS-20P, JK-B1AxxS-15P, JK-B2AxxS-15P and JK-B2AxxS-20P protection boards are suitable for lithium battery packs with 7-24 strings of cells, and the wiring methods of battery packs with different number of cells are different.

4.2. Line connection

JK-BD6AxxS-10P 、 JK-BD6AxxS-15P 、 JK-BD6AxxS-20P 、 JK-B1AxxS-15P、 JK-B2AxxS-15P、 JK-B2AxxS-20P For lithium-ion battery packs with 7-24 series of cells, the connection methods for different number of cells are different. The specific connection methods are shown in the following figure. Attention: Always attach sense/balancing wire to the Positive side of the cells,

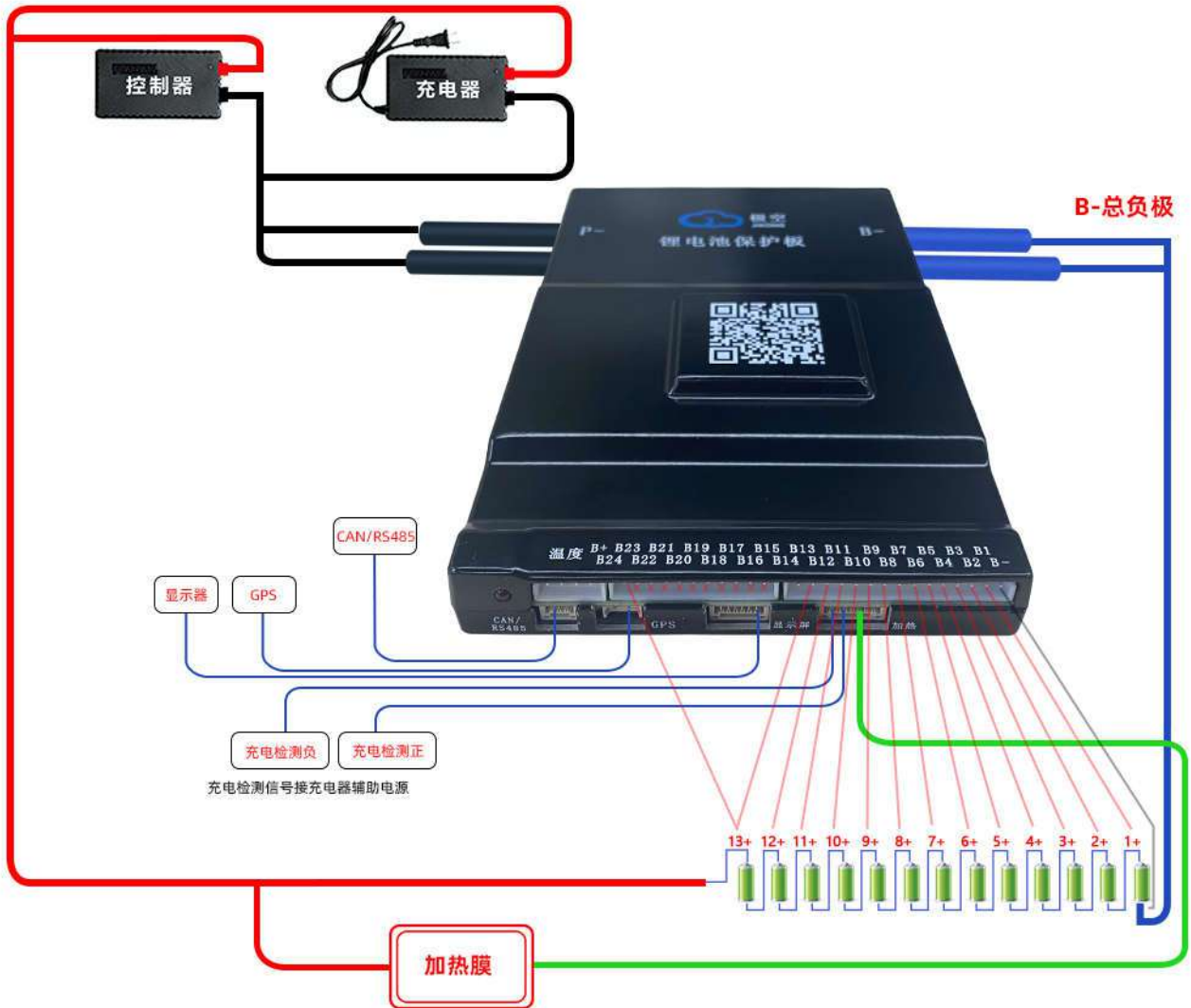

Figure 7 Wiring diagram of heating function

24串连接图

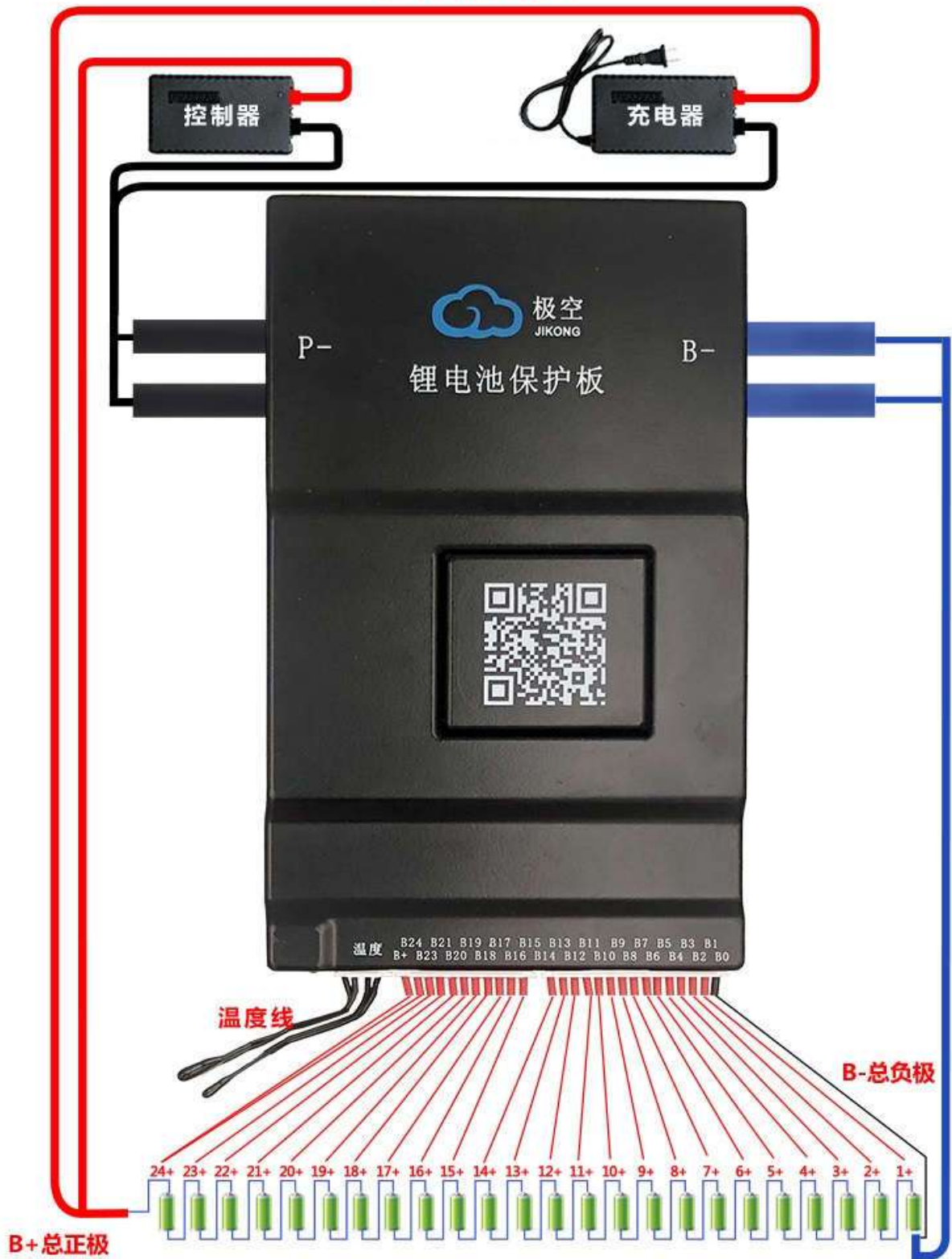

Figure 8 Diagram of 24 series battery connection

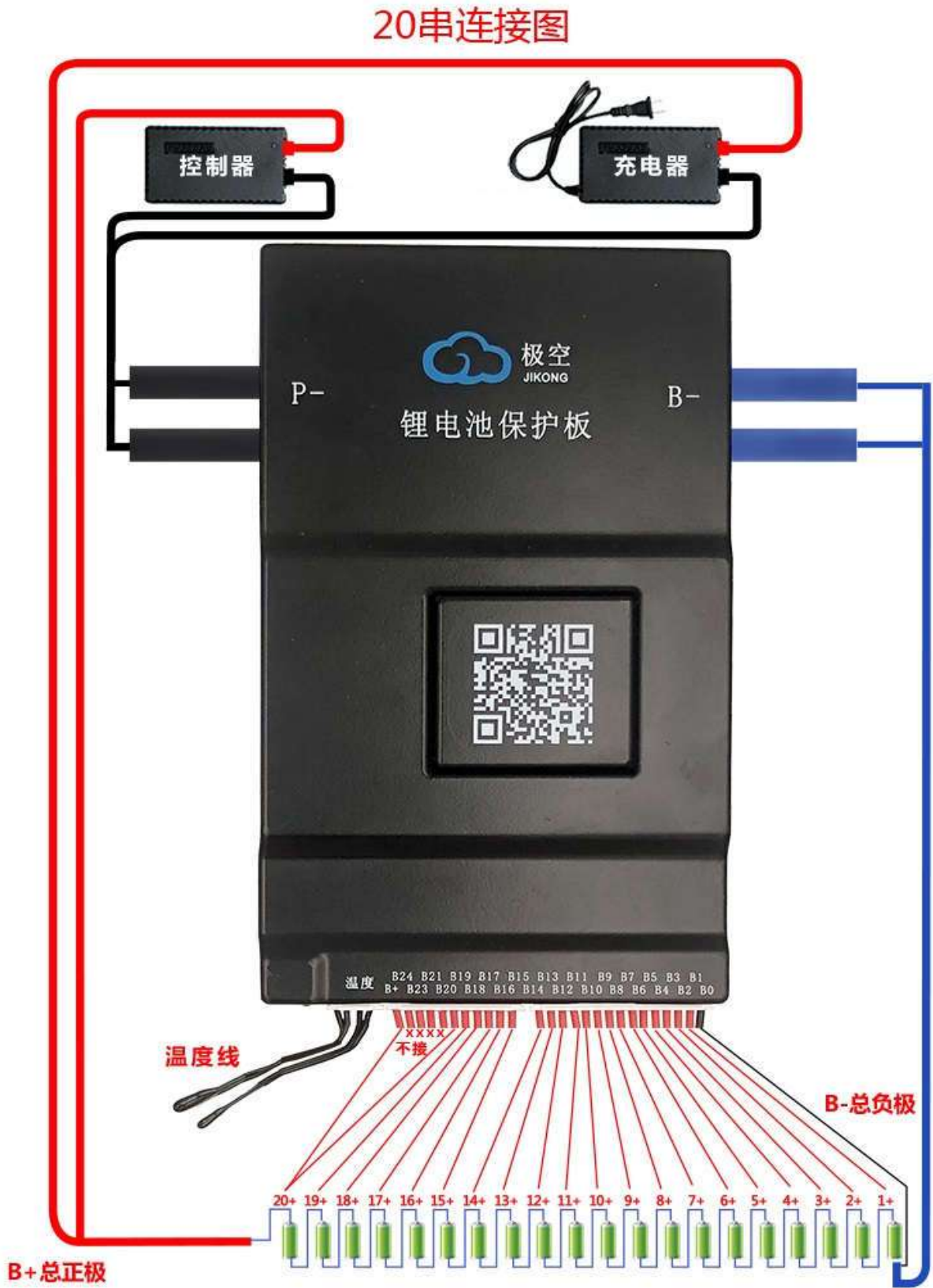

Figure 9 Diagram of 20 series battery connection

17串连接图

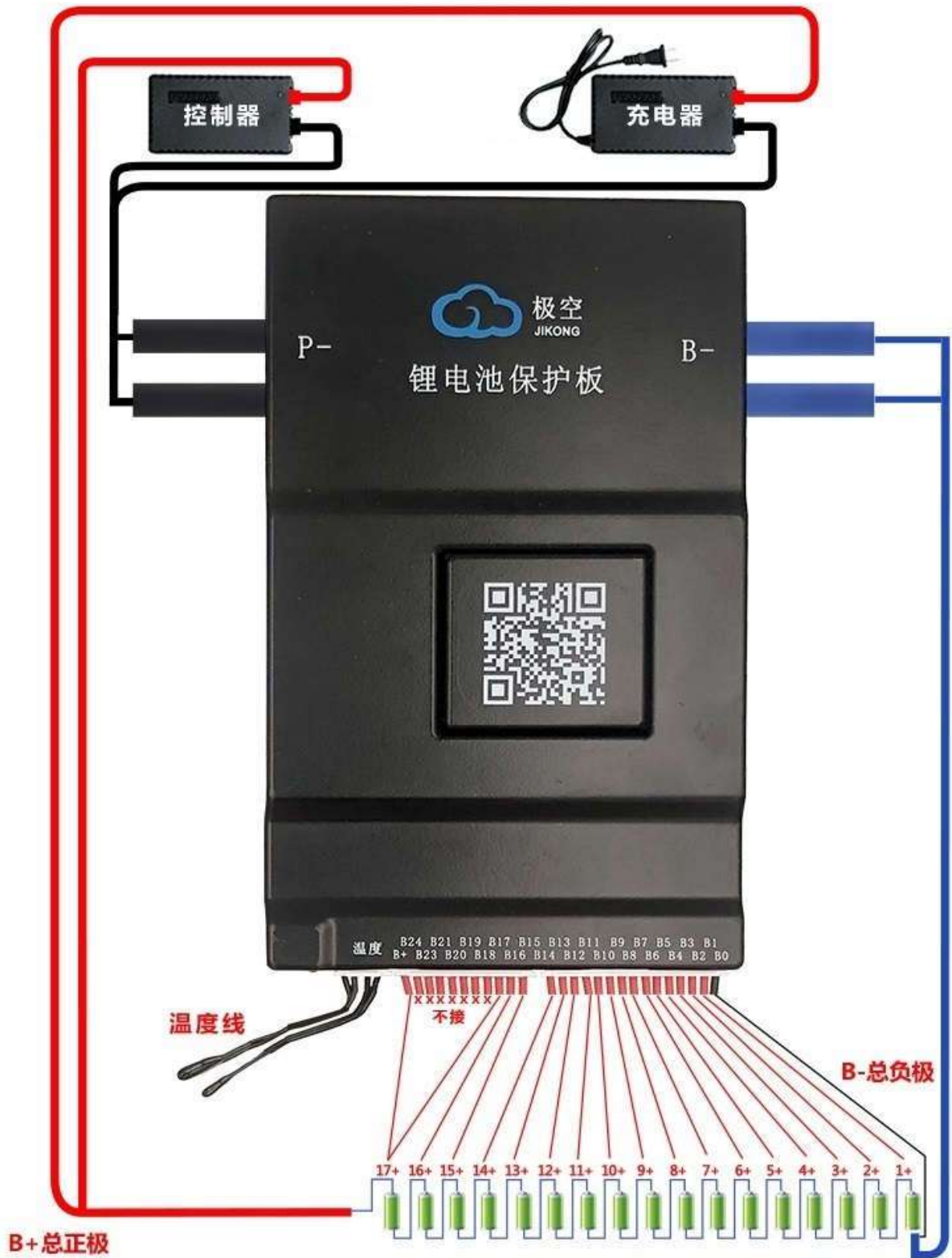

Figure 10 Diagram of 17 series battery connection

13串连接图

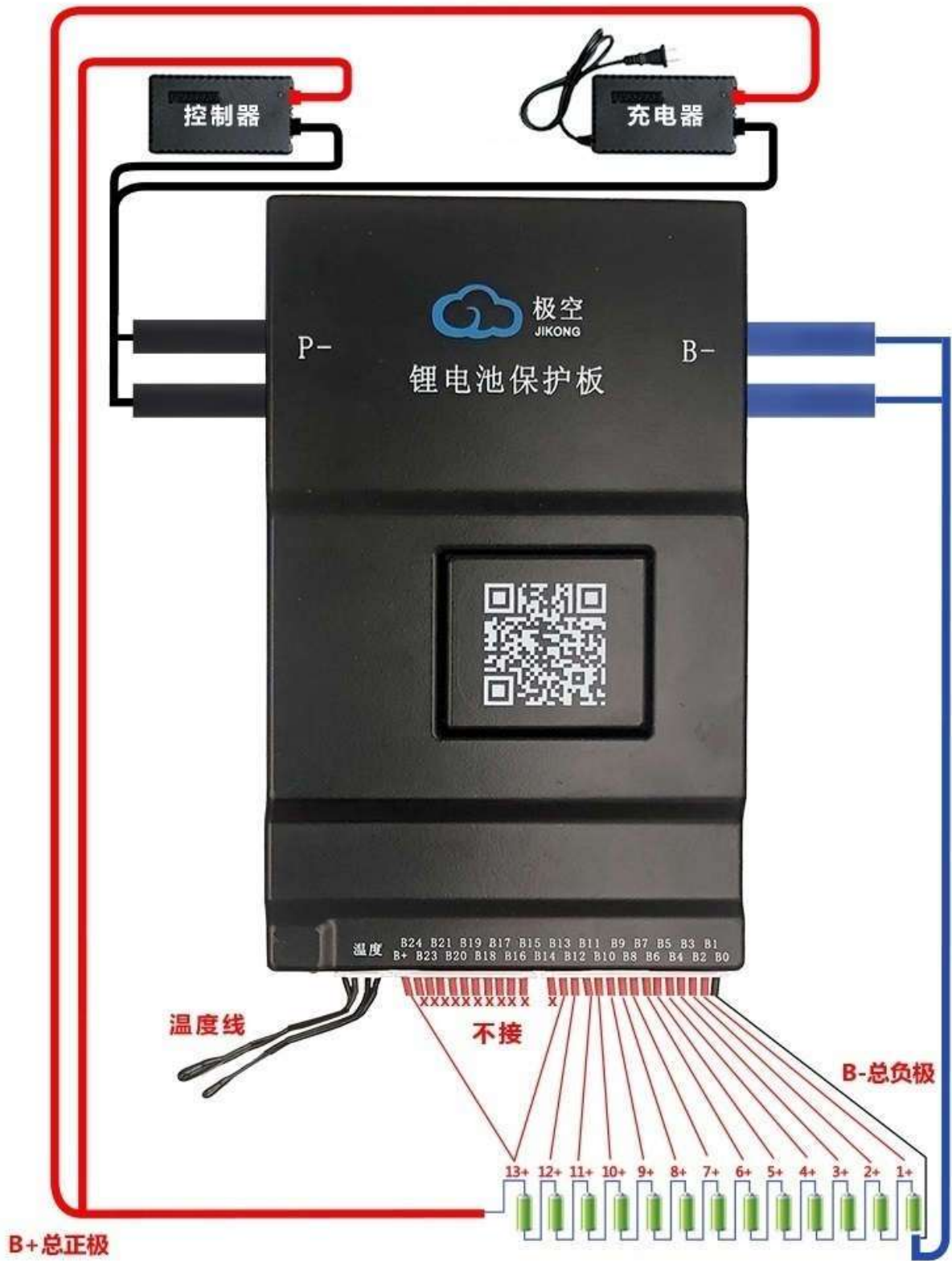

Figure 11 Diagram of 13 series battery connection

JK-BD6xxS-6P and JK-BD 6xxS-8P For lithium-ion battery packs with 7-24 series of cells, the connection methods for different number of cells are different. The specific connection methods are shown in the following figure. Attention: Always attach sense/balancing wire to the Positive side of the cells,

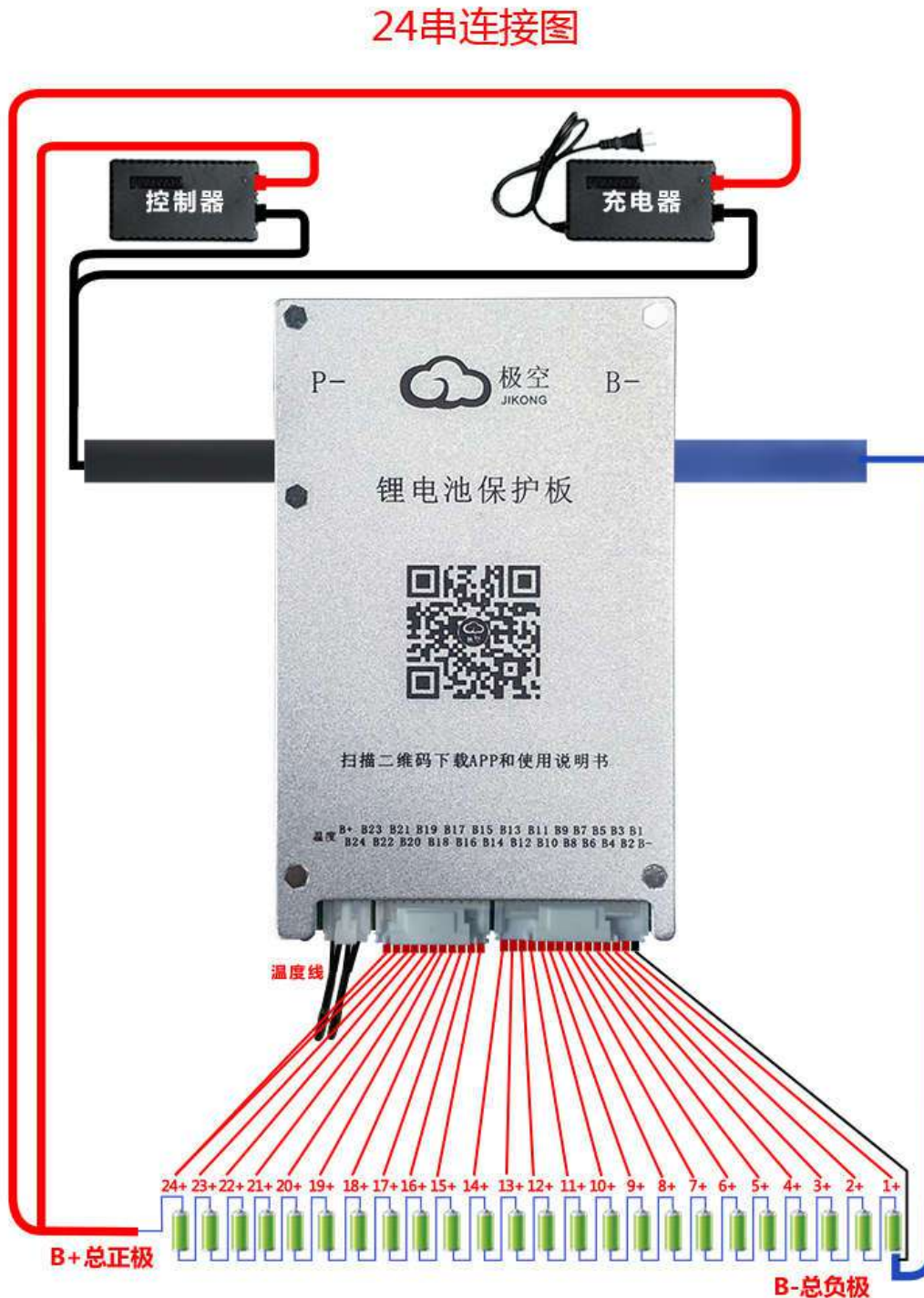

Figure 12 Diagram of 24 series battery connection

20串连接图

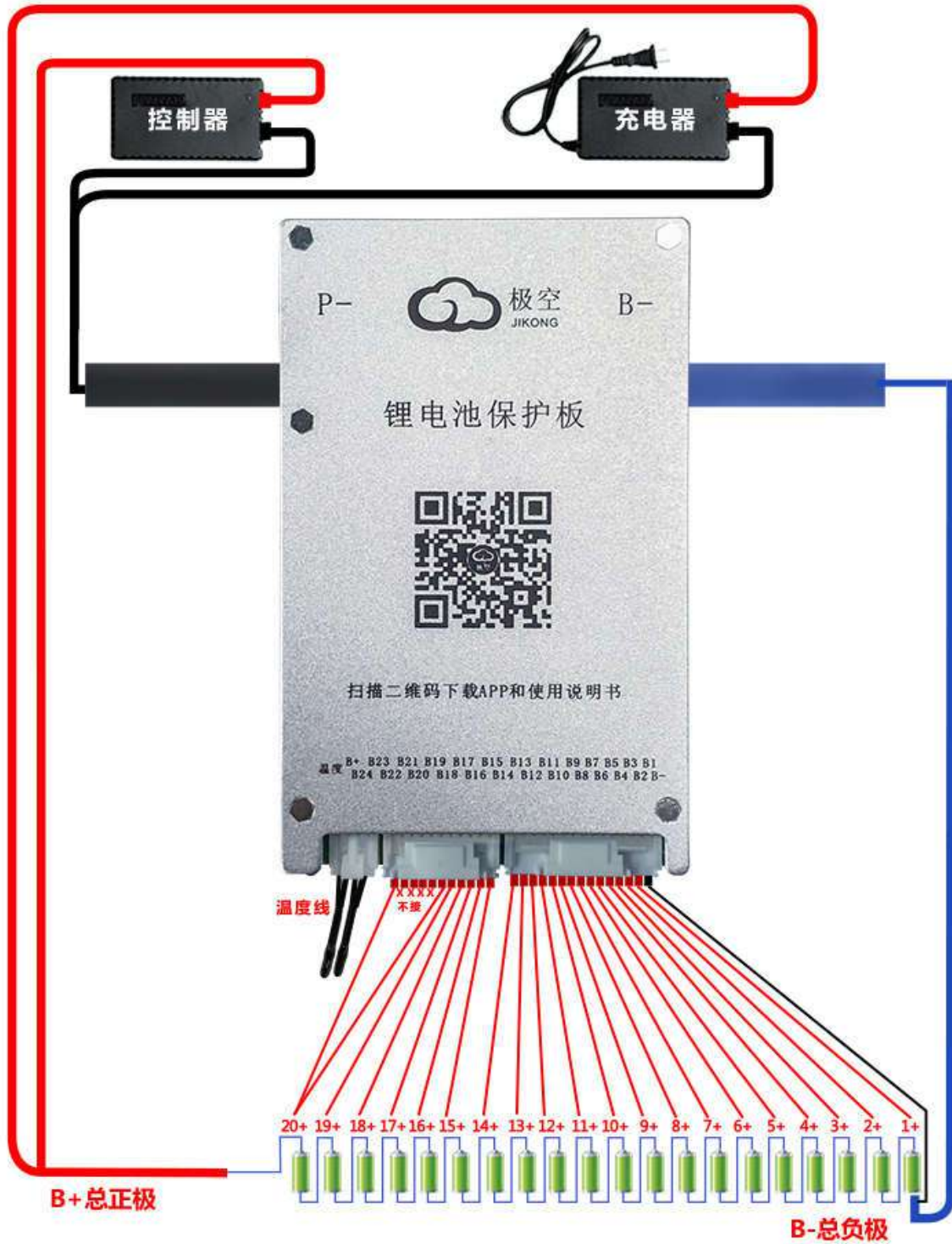

Figure 13 Diagram of 20 series battery connection

17串连接图

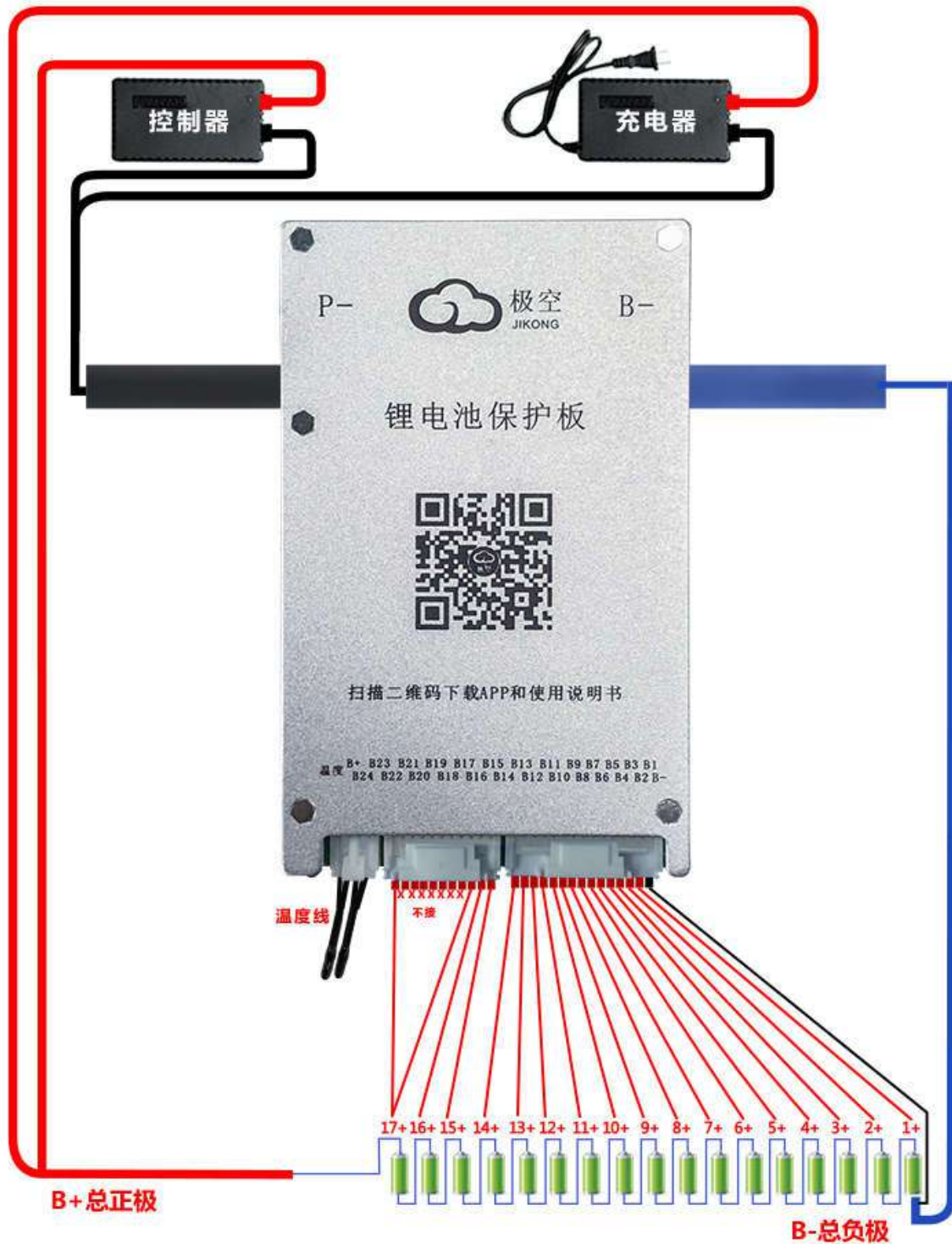

Figure 14 Diagram of 17 series battery connection

13串连接图

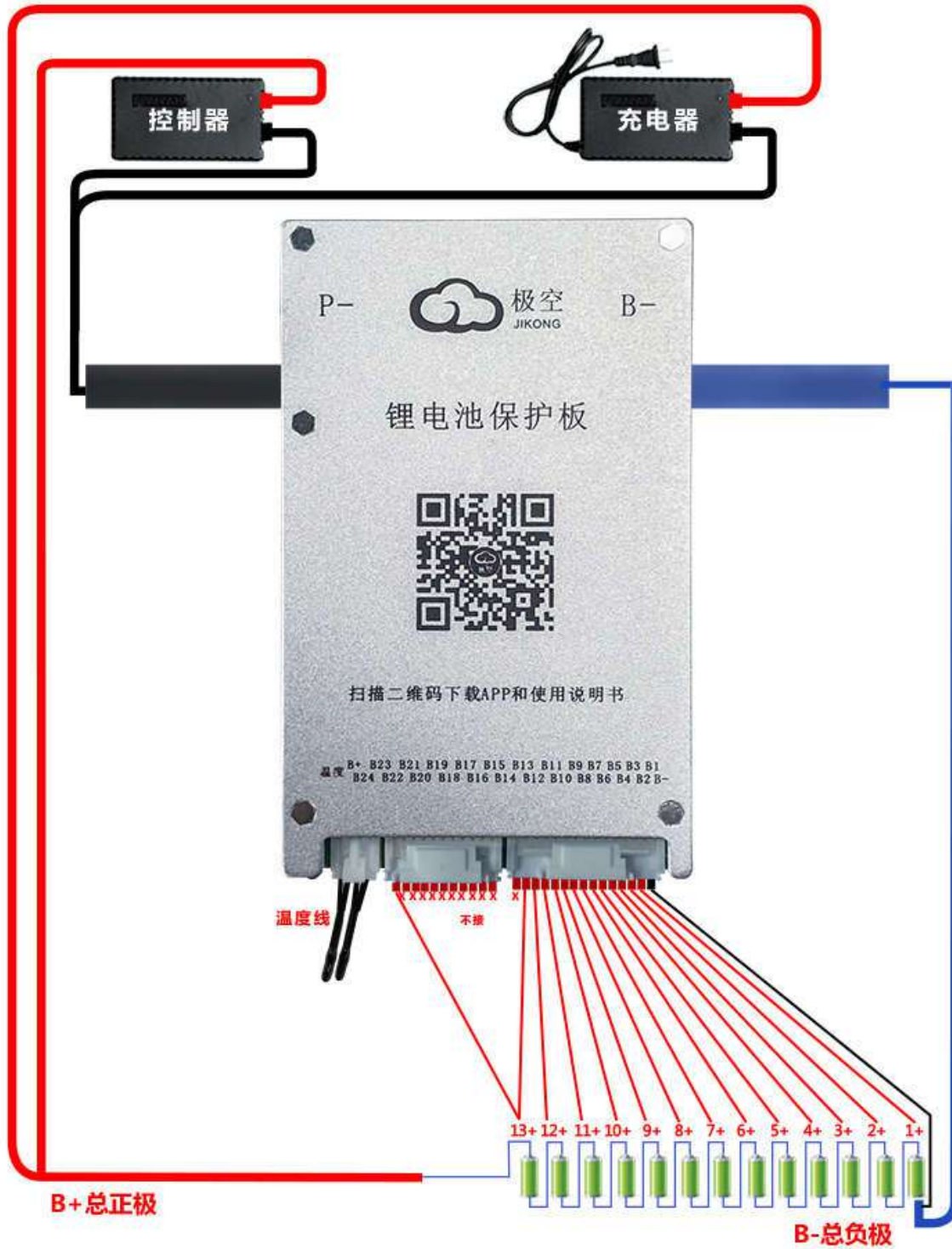

Figure 15 Diagram of 13 series battery connection

4.3. APP installation

Mobile APP matching the product can be obtained by scanning the QR code shown in Figure 31.

Android Version 7 minimum is required for the Android APP.



Figure 16 Mobile APP link QR code

Download link-IOS : Search (JIKONG BMS) in the APP STORE

Download link-Andriod : <https://www.pgyer.com/Cfq3> Instructions:

5. Use and operation

5.1. Prepare and check before use

Before turning on the BMS, make sure that the sense/balancing lines is connected properly again, "P-/C-" (1st Cell Negative) and "B-" (B- Negative out from the BMS) are connected correctly. Check if the BMS is securely fixed to the Cells, and make sure it is correct before it can be connected to the BMS. Otherwise, it may cause serious consequences such as abnormal operation or even failure.

5.2. Power on protection board

After confirming that the above conditions are correct, the BMS can be powered up. The BMS has no power-on control switch and is designed for charging activation mode (charger voltage is 5V higher than battery voltage), that is, after the battery is assembled, you need to connect the charger to make the BMS work. You can also activate the BMS using the new LCD screens or Switches that come with the BMS. Another method (without switches or LCD screen) prior to connecting the assembled battery to the system is to Connect the Positive side of the 9 volt (max) to the Negative end of the cells, the B- lead of the BMS. Then connect the Negative side of the 9 volt battery to the C-/P- lead of the BMS for one second or until you hear a Beep. It is very fast)

5.3. APP Operating Instructions

5.3.1. Equipment operation

Noted:

- 1. For Android 12 and above systems, app needs to be allowed to obtain mobile GPS permission, and it is always allowed. (this is the setting of Android 12 system. BMS will not always read the user's data.)**
- 2. It is recommended that the customer update the app in time. The app will repair the bug within a week according to the customer's feedback, and it will also be updated according to the design reasons.**

5.3.1.1. Device connection

First turn on the Bluetooth of the mobile phone, and then turn on the app, the app requires access to location, as shown in Figure 17. Click the icon in the upper left corner to scan the device. After the scanning is completed, click the name of the device to be connected, such as "**JK-BD6A24S10P**". During the first connection, the app will prompt you to enter a password. The default password of the device is "**1234**". After the device is connected, the app will automatically record the password. The next connection does not need to enter a password. After the app is opened, it will automatically connect.

The default BMS Password is "**1234**". The default BMS Password for Internal Configuration is "**123456**". The password input interface is shown in Figure 18.

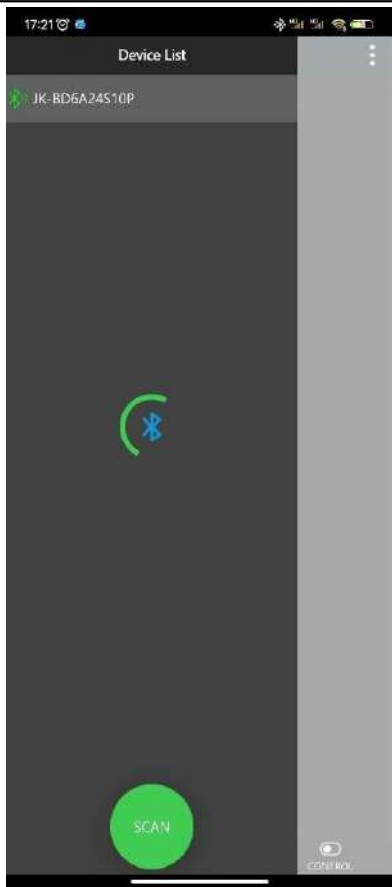

Figure 17 Device scanning



Figure 18 Password input

5.3.1.2. Modify password and name

You can change the device name and password by clicking the Pen icon to the right of the device list after the device is connected. Modify the device name interface as shown in Figure 19. Note that the device name only supports English or numbers, not Chinese names and Chinese characters.

Modify the password interface as shown in Figure 20 To change the password of the device, you must first enter the old password of the device, and only if the current password is correct can you enter the option of entering a new password. After entering the new password twice, click OK to complete the device password change.

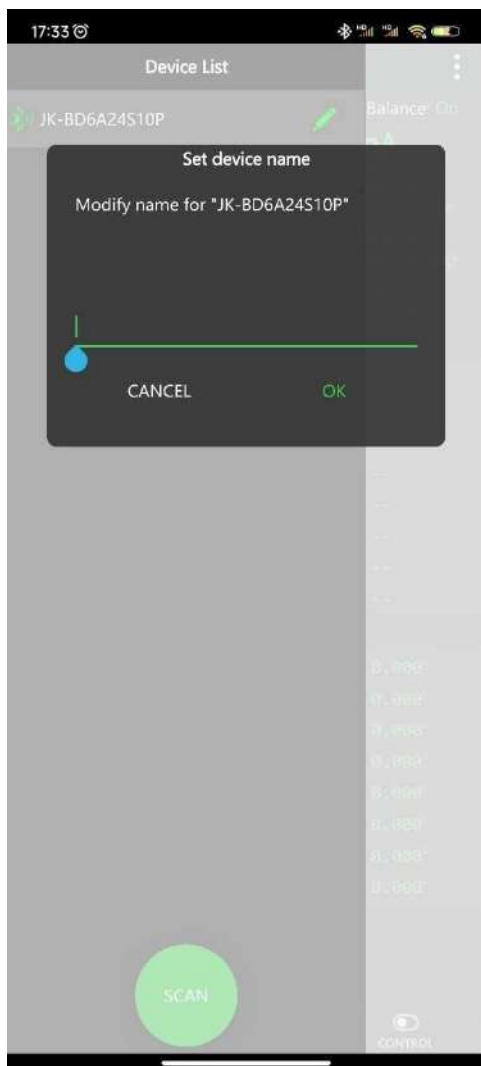

Figure 19 Name Modification

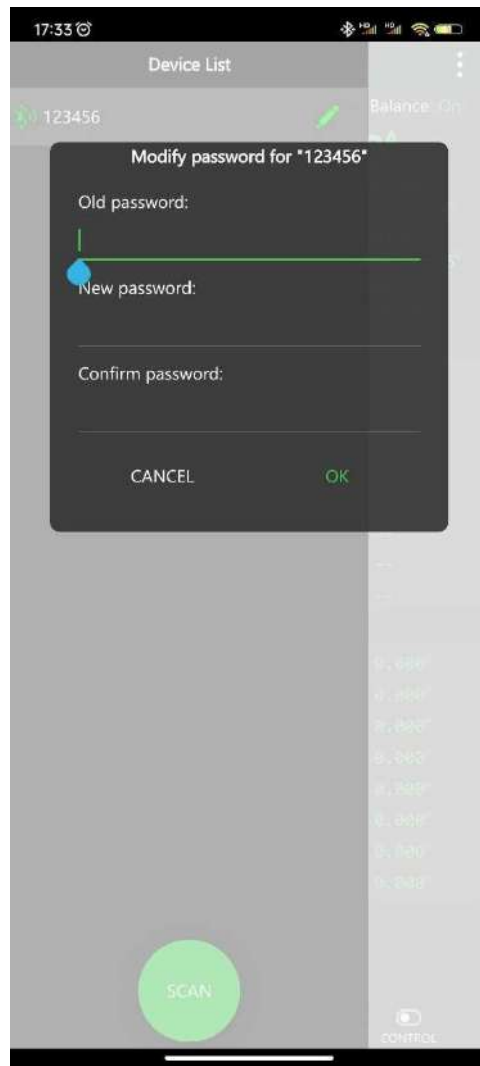

Figure 20 Password Modification

5.3.1 Status view

The real-time status interface is shown in 21.

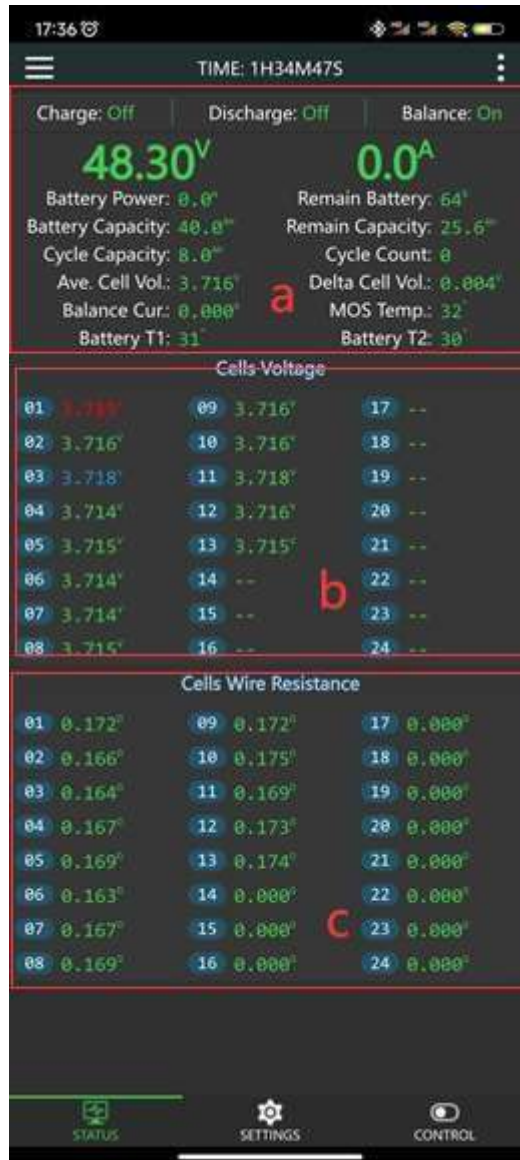

Figure 21 Real-time status display

Zone 1 in the picture is the battery comprehensive information bar. The parameters are defined as follows:

A) Runtime

Running time represents the total running time from the first start of the BMS to now.

B) CHARGE

Indicates the current switch state of the BMS charging MOS. When "On" is displayed, it indicates that the current BMS charging MOS is on and the battery is allowed to charge. When "Off" is displayed, it indicates that the current BMS charging MOS is off and the battery is not allowed to charge.

C) DISCHARGE

Indicates the current switch state of the BMS discharge MOS. When "On" is displayed, it indicates that the current BMS discharge MOS is on and the battery is allowed to discharge. When "Off" is displayed, it indicates that the current BMS discharge MOS is off and the battery is not allowed to discharge.

D) Balance

Equilibrium represents the switching state of the current BMS Active Balancing switch. When "On" is displayed, the BMS is automatically balancing when the balance trigger condition is reached; When "Off" is displayed, it means balancing is shutdown, and the BMS will not balance the battery.

E) Voltage

The voltage voltage region shows the total voltage of the current battery in real time. The total voltage is the sum of all the individual currents.

F) Current

The current area shows the total current of the current battery in real time. The current is positive when the battery is charging and negative when the battery is discharging

G) Power

Battery power represents the total power output or input of the current battery, which is the product of the absolute value of the current battery voltage and current.

H) Battery Capacity

Represents the actual battery capacity calculated by the current BMS with high precision SOC in AH. (This value needs the battery to do a full discharge and charge cycle before it can be updated).

I) Remaining capacity

Remaining capacity refers to the remaining capacity of the current battery, unit: ah.

J) cycle capacity

Cycle capacity cycle capacity refers to the cumulative discharge capacity of the battery, in AH units.

k)Number of cycles

The number of cycles indicates the number of charging saturation times of the current battery, unit:times

L) Monomer average

Indicates the average voltage of the current battery, unit: v.

M) Maximum differential pressure

The maximum voltage difference indicates the difference between the highest cell voltage and the lowest cell voltage of the current whole battery, unit: v.

N) balancing current

When the BMS turns on the Active Balancing function and reaches the Active Balancing condition, the Active Balancing current display area displays the Active Balancing current in real time, unit: A.

When Active Balancing is in progress, the single voltage display area of the real-time state, with blue representing the highest voltage cell and red representing the lowest voltage cell.

Pool. Balanced negative current indicates that the battery is discharging, blue flashes, positive current of balanced current indicates that the battery is charging, and red flashes. The BMS uses active balancing technology. The principle of balancing is to take power from high voltage cells, store them in the BMS, and then release them to low voltage cells.

O) MOS

Real time display of current BMS power MOS temperature, unit: °C

P) Battery temperature 1

"NA" is displayed when the temperature sensor 1 is not installed, and the temperature of the temperature sensor 1 is displayed in real time when the temperature sensor is installed in units of: . C.

Q) Battery temperature 2

"NA" is displayed when the temperature sensor 2 is not installed, and the temperature of temperature sensor 2 is displayed in real time when the temperature sensor is installed in units of: > C.

Zone 2 in the figure is a single voltage region. Real-time display of voltage data for each individual in the battery pack, where red indicates the lowest voltage monomer and blue indicates the highest voltage monomer.

Zone 3 in the figure is the sense/balancing lines resistance area. The sense/balancing lines resistance is the sense/balancing lines resistance obtained by the BMS self-test. This value is only a preliminary calculation to prevent misconnection or poor contact. When the sense/balancing lines resistance exceeds a certain value, it appears yellow, and Active Balancing cannot be turned on at this time.

5.3.2 Parameter setting

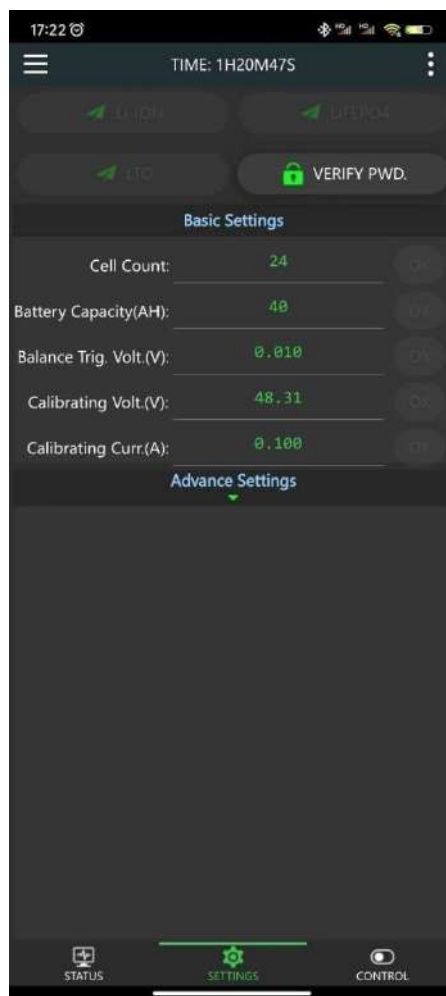

Figure 22 Settings page display

If you need to modify the working parameters of the protection panel, you must first click the Authorization Settings button and enter the parameter settings password. Set permissions to validate parameters. The parameter setting password factory defaults to "123456". The parameters of the BMS can only be modified after the parameters are entered correctly and the password is set. The parameter setting password and the device Bluetooth connection password are independent of each other.

a) One-click Lifepo4

One-click Lifepo4 button can change all working parameters of the BMS to Lifepo4 battery parameters. The default values of Lifepo4 parameters are listed in the appendix. These should be adjusted for your specific battery cell specifications for proper operation.

b) One-click lithium iron

One-click lithium iron can modify all the working parameters of the BMS to triple battery parameters. The default values of triple lithium parameters are listed in the appendix. These should be adjusted for your specific battery cell specifications for proper operation.

c) One-click Lithium Titanate

One-click Lithium Titanate, all working parameters of the BMS can be modified to the Lithium Titanate battery parameters. The default values of the Lithium Titanate parameters are listed in the appendix. These should be adjusted for your specific battery cell specifications for proper operation.

d) Number of monomers

Number of units Indicates the number of cells in the current battery. Please set this value accurately before use, otherwise the BMS will not work properly.

e) Battery capacity

Battery capacity This value is the designed capacity of the battery.

f) f)Trigger Balanced Pressure Differential

When the Active Balancing switch is turned on, and when the maximum voltage difference of the battery pack exceeds this value and the current monomer voltage exceeds the balancing start voltage, Active Balancing starts until the voltage difference is lower than this value or the monomer voltage is lower than the Active Balancing start voltage. For example, set the Active Balancing trigger pressure difference to 0.010V, start Active Balancing when the battery pack pressure difference is greater than 0.010V, and end Active Balancing when it is lower than 0.01V. (It is recommended to set the balance trigger pressure difference of 0.005V for batteries above 50AH and 0.01V for batteries below 50AH).

g) Voltage calibration

The voltage calibration function can be used to calibrate the accuracy of the BMS voltage collection. When errors are found between the total voltage collected by the BMS and the total voltage of the battery, the BMS can be calibrated using the voltage calibration function. The calibration method is to get the actual voltage from the Battery Terminals with charge / discharge OFF then enter the "actual" total battery voltage and click on the Settings button after the voltage calibration to complete the calibration. Remember to turn charge/discharge back on.

h) Current calibration

The current calibration function can be used to calibrate the accuracy of current collection from the BMS. When errors are found between the total current collected by the BMS and the actual current of the battery, the current calibration function can be used to calibrate the BMS. The calibration method is to fill in the current measured total battery current and click on the Settings button after the current calibration to complete the calibration.

i) Single Under-voltage Protection,Single Under-voltage Recovery"

"Single under-voltage protection" refers to the cut-off voltage of the cells. When any single Cell within the battery pack is lower than this value, a "single under-voltage alarm" is generated, and the BMS turns off the discharging MOS. At this time, the battery cannot be discharged and can only be charged. When the alarm is generated, only after all the individual voltage values exceed the value of "single voltage recovery", the BMS removes the "single under-voltage alarm" and turns on the discharge MOS.

j) "Monomer overcharge voltage", "monomer overcharge recovery"

"Monomer overcharge voltage" refers to the saturation voltage of the battery cell. As long as the voltage of any monomer in the battery pack exceeds this value, a 'monomer overcharge alarm' will be generated. At the same time, the protection board will turn off the charging MOS, and the battery can't be charged but can only be discharged. When the alarm is generated, only when the voltage value of all monomers is lower than the value of "monomer overcharge recovery", the protection board will release the "monomer overcharge alarm" and turn on the charging MOS at the same time.

k) Auto Shutdown Voltage

The automatic shut-off voltage indicates the lowest voltage at which the BMS operates. When the lowest cell voltage in the battery pack reaches this value, the BMS shuts down. This value must be lower than "Single under-voltage protection".

l) "Maximum Charging Current ", " charging Over-current Delay"," Charging Over-current Release "

When charging the battery pack, the current exceeds the "maximum charging current" and the duration exceeds the "charging Over-current delay", the BMS generates the "charging Over- current alarm" and turns off the charging MOS. After the alarm is generated, after the "charging Over-current relief" time, the BMS relieves the charging Over-current alarm and turns on the charging MOS again.

For example, set the "maximum charging current" to 10A, "charging Over-current delay" to 10 seconds,

and "charging Over-current relief" to 50 seconds. When the charging current exceeds 10A continuously for 10 seconds during the charging process, the BMS will generate a 'charging Over-current alarm', turn off the charging MOS at the same time, remove the 'charging Over-current alarm' 50 seconds after the alarm is generated, and turn on the charging MOS again.

m) "Maximum Discharge Current"," Discharge Over-current Delay"," Discharge Over-current Release"

When the battery pack is discharged, and the current exceeds the "maximum discharge current" and the duration exceeds the "discharge Over-current delay", the BMS generates a "discharge Over-current alarm" and turns off the discharging MOS. After the alarm is generated, after the time of "discharge Over-current relief", the BMS relieves the "discharge Over-current alarm" and turns on the discharge MOS again.

Examples include setting maximum discharge current to 100A,'discharge Over-current delay to 10 seconds, and discharge Over-current relief' to 50 seconds. When the discharge current exceeds 100A continuously for 10 seconds during the discharge process, the BMS will produce a 'discharge Over-current alarm', turn off the discharge MOS at the same time, remove the 'discharge Over-current alarm' 50 seconds after the alarm is generated, and turn On the discharge MOS again..

n) Short circuit protection release

When the short-circuit protection occurs, the short-circuit protection is removed after the time set by 'Release of Short-Circuit Protection'.

o) Balancing Starting Voltage

The balancing starting voltage is used to control the voltage stage of balancing. Balancing will be triggered when the cell voltage exceeds this value and the maximum voltage difference of the battery pack exceeds the balancing trigger voltage difference.

p) Maximum balancing current

The balancing current represents the continuous current of high-voltage battery discharge and low-voltage battery charging during the process of energy transfer. The maximum balancing current refers to the maximum current in the process of energy transfer, and the maximum balancing current should not exceed 0.1C. For example, 20Ah battery shall not exceed $20 \times 0.1 = 2A$.

q) "Charging over-temperature protection" and "charging over-temperature recovery"

During charging, when the battery temperature exceeds the value of "Charge Over Temperature Protection", the BMS generates a warning of "Charge Over Temperature Protection", and the BMS turns off the charging MOS. After the alarm is generated, and the temperature falls below "Charge Over Temperature Recovery", the BMS removes the warning of "Charge Over Temperature Protection" and turns on the charging MOS again.

r) "Charging low temperature protection" and "charging low temperature recovery"

During the charging process, when the battery temperature is below the value of "Charging Low

Temperature Protection", the BMS generates a warning of "Charging Low Temperature Protection", and the BMS turns off the charging MOS. After the alarm is generated, and the temperature is higher than "Charging Low Temperature Recovery", the BMS removes the "Charging Low Temperature Protection" warning and restarts the charging MOS.

s) "MOS over-temperature protection" and "MOS over-temperature recovery"

When the MOS temperature exceeds the value of "MOS over-temperature protection", the BMS generates a "MOS over-temperature alarm" and turns off the charging and discharging MOS at the same time, so the battery cannot be charged or discharged. After the alarm is generated, and the MOS temperature reaches lower than the value of "MOS Over Temperature Recovery", the BMS will release the "MOS Over Temperature Alarm" and turn on the charging and discharging MOS again (the MOS Over Temperature Protection Value is 75 degrees C and the MOS Over Temperature Recovery Value is 65 degrees C, (these are the factory default values and cannot be modified).

Note: Any parameter modification, please refer to the instruction manual, inappropriate parameters may make the BMS not work properly, or even damage the BMS. After any parameter modification, you need to click on the Settings button after the parameter to complete the parameter issue. When the BMS successfully receives the parameter, it will make a "drop" sound.

5.3.3 BMS control

The BMS control page is shown in Figure 23. The BMS control can switch the charging , discharging, and balancing functions of the BMS and restore the factory settings.

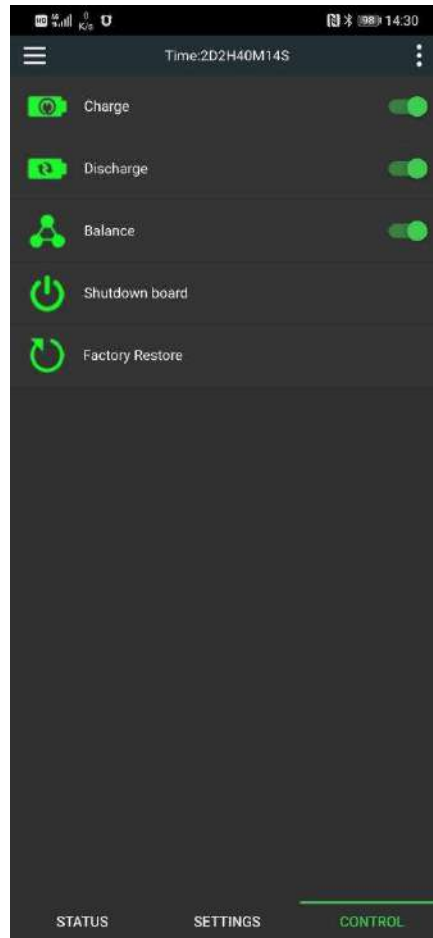

Figure 23 BMS control page

6. Safety protection measures and precautions

Please read the operation manual carefully before use, and connecting the wires according to the wiring diagram of the corresponding string number, from the negative pole to the positive pole. After the balancing wire is connected, use a multi-meter again to confirm that it is correct before connecting the BMS.

The default password of the BMS is "1234". After the mobile app is connected to the BMS, please modify the connection password in time to prevent others from connecting.

It is not allowed to refit the power line of the BMS without permission. Refitting the power line without permission will cause uneven Over-current of the BMS and damage the BMS.

7. Transportation and storage

7.1. Transportation

The packed product is not directly affected by rain or snow and is subject to severe bumps. It can be transported by normal means of transport. Corrosives such as acids and bases are not allowed to be kept together during transportation.

7.2. Store

The packed products should be stored in a permanent warehouse with a temperature ranging from 0 to 35 and a relative humidity not exceeding 80%. The warehouse should be free from acid and alkali, corrosive gases, strong mechanical vibration and impact, and strong magnetic field.

Appendix1 Default Parameters for Lithium-Ion, Lithium Iron Phosphate, Lithium Titanate

NUM	PARA	LI-ION	LIFEPO4	LTO	UNIT
1	Single under-voltage protection	2.9	2.7	1.8	V
2	Single under-voltage protection recovery	3.2	2.9	2.0	V
3	Monomer Overcharge Voltage	4.2	3.6	2.7	V
4	Monomer Overcharge Protection Recovery	4.1	3.5	2.4	V
5	Trigger Balanced Pressure Differential	0.01	0.010	0.01	V
6	Auto Shutdown Voltage	2.8	2.6	1.7	V
7	Charging Over-current Protection Delay	30	30	30	秒
8	Charging Over-current Protection Release Time	60	60	60	秒
9	Discharge Over-current Protection Delay	30	30	30	秒
10	Discharge Over-current Protection Release Time	60	60	60	秒
11	Release time of short circuit protection	60	60	60	秒
12	Charging Over-Temperature Protection Temperature	60	60	60	°C
13	Charging Over-Temperature Recovery Temperature	55	55	55	°C
14	Discharge Over-Temperature Protection	60	60	60	°C
15	Discharge Over-Temperature Recovery Temperature	55	55	55	°C
16	Charging Low Temperature Protection Temperature	-20	0	-20	°C
17	Charging Low Temperature Recovery Temperature	-10	5	-10	°C
18	MOS Over-Temperature protection temperature	75	75	75	°C
19	MOS Over Temperature Protection Recovery	70	70	70	°C